

Article number: 439600100

Description: Rota-fix shaft-hub connection FS100x145

Note: Self centering - very high torque.

Measures

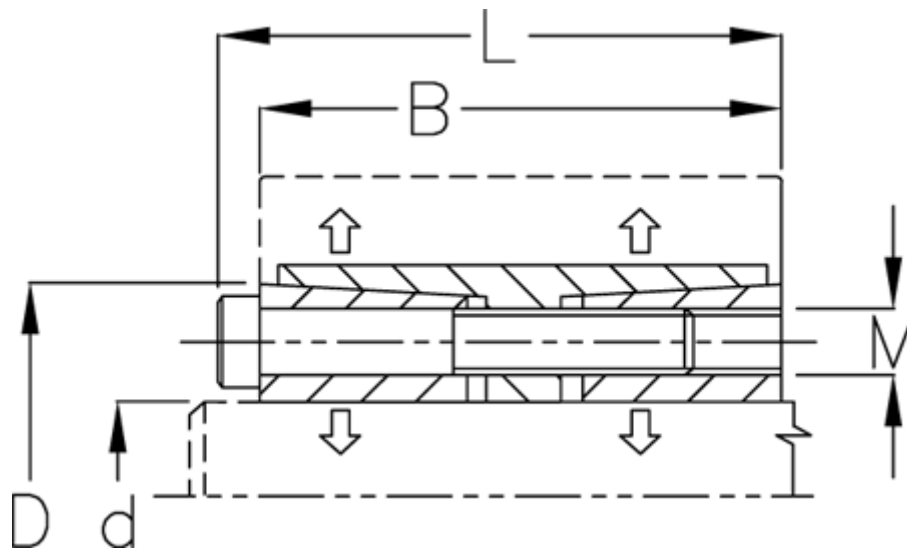

B mm	= 72
d H8 mm	= 100
D mm	= 145
Fit tolerance	= Aksel h8, Nav H8
F kN torque	= 388.0
L mm	= 84
M mm	= M12
P N/mm ² surface pressure on shaft/hub	= 148

Surface roughness	= R? ? 3.2 μm
T N m torque	= 19400
Ts N m bolt tightening torque	= 145.0